

Natural Alignment & Quartic Coupling Unification in multi-Higgs Doublet Models

APOSTOLOS PILAFTSIS

*Department of Physics and Astronomy, University of Manchester,
Manchester M13 9PL, United Kingdom*

SCALARS 2019

Warsaw, Poland, 11–14 September 2019

- Based on:
- P.S.B. Dev, AP, JHEP1412 (2014) 024
 - AP, PRD93 (2016) 075012
 - N. Darvishi, AP, PRD99 (2019) 115014

Outline:

- Brief history of **symmetries** for **natural SM alignment**
- **SM alignment** in the **2HDM** and **beyond**
- **Quartic coupling unification** in the **2HDM**
- Phenomenological implications at the **LHC**
- **Conclusions**

• Brief history of **symmetries** for **natural SM alignment**

- Flavour unitarity of the CKM mixing matrix
[Gell-Mann, Levy '60; Cabbibo '63; Kobayashi, Maskawa '73]
- GIM mechanism to explain the smallness of the strangeness-changing interaction at the quantum level (requires the existence of the c -quark)
[Glashow, Iliopoulos, Maiani '70]
- Conditions for diagonal neutral currents in Z -boson interactions to quarks
[Paschos '77]
- **Natural** diagonal neutral currents in Z - & multi-Higgs-boson interactions to quarks
[Glashow, Weinberg '77]
- Renormalizable models with partial flavour **non-conservation** at tree level (**GIM suppressed**).
[Branco, Grimus, Lavoura '96]
- Yukawa **alignment** in the 2HDM broken by RG effects (**not enforced by symmetries**)
[Pich, Tuzon '09]
- **Natural SM alignment** of **New Physics** [this talk]

• SM Alignment in the 2HDM and beyond

• 2HDM potential

[T. D. Lee '73;

Review: Branco, Ferreira, Lavoura, Rebelo, Sher, Silva '12.]

$$\begin{aligned}
 V = & -\mu_1^2(\phi_1^\dagger\phi_1) - \mu_2^2(\phi_2^\dagger\phi_2) - m_{12}^2(\phi_1^\dagger\phi_2) - m_{12}^{*2}(\phi_2^\dagger\phi_1) \\
 & + \lambda_1(\phi_1^\dagger\phi_1)^2 + \lambda_2(\phi_2^\dagger\phi_2)^2 + \lambda_3(\phi_1^\dagger\phi_1)(\phi_2^\dagger\phi_2) + \lambda_4(\phi_1^\dagger\phi_2)(\phi_2^\dagger\phi_1) \\
 & + \frac{\lambda_5}{2}(\phi_1^\dagger\phi_2)^2 + \frac{\lambda_5^*}{2}(\phi_2^\dagger\phi_1)^2 + \lambda_6(\phi_1^\dagger\phi_1)(\phi_1^\dagger\phi_2) + \lambda_6^*(\phi_1^\dagger\phi_1)(\phi_2^\dagger\phi_1) \\
 & + \lambda_7(\phi_2^\dagger\phi_2)(\phi_1^\dagger\phi_2) + \lambda_7^*(\phi_2^\dagger\phi_2)(\phi_2^\dagger\phi_1) .
 \end{aligned}$$

• Physical (CP-conserving) spectrum:

CP-even Higgs bosons H and h ; CP-odd scalar a ; charged scalars h^\pm .

• Higgs coupling to gauge bosons $V = W, Z$:

$$g_{HVV} = \cos(\beta - \alpha), \quad g_{hVV} = \sin(\beta - \alpha),$$

where $\tan \beta = \langle \phi_2 \rangle / \langle \phi_1 \rangle$ and α diagonalizes the CP-even mass matrix.

- **Global fit to SM mis-alignment**

[e.g. D. Chowdhury, O. Eberhardt, JHEP11 (2015) 052.]

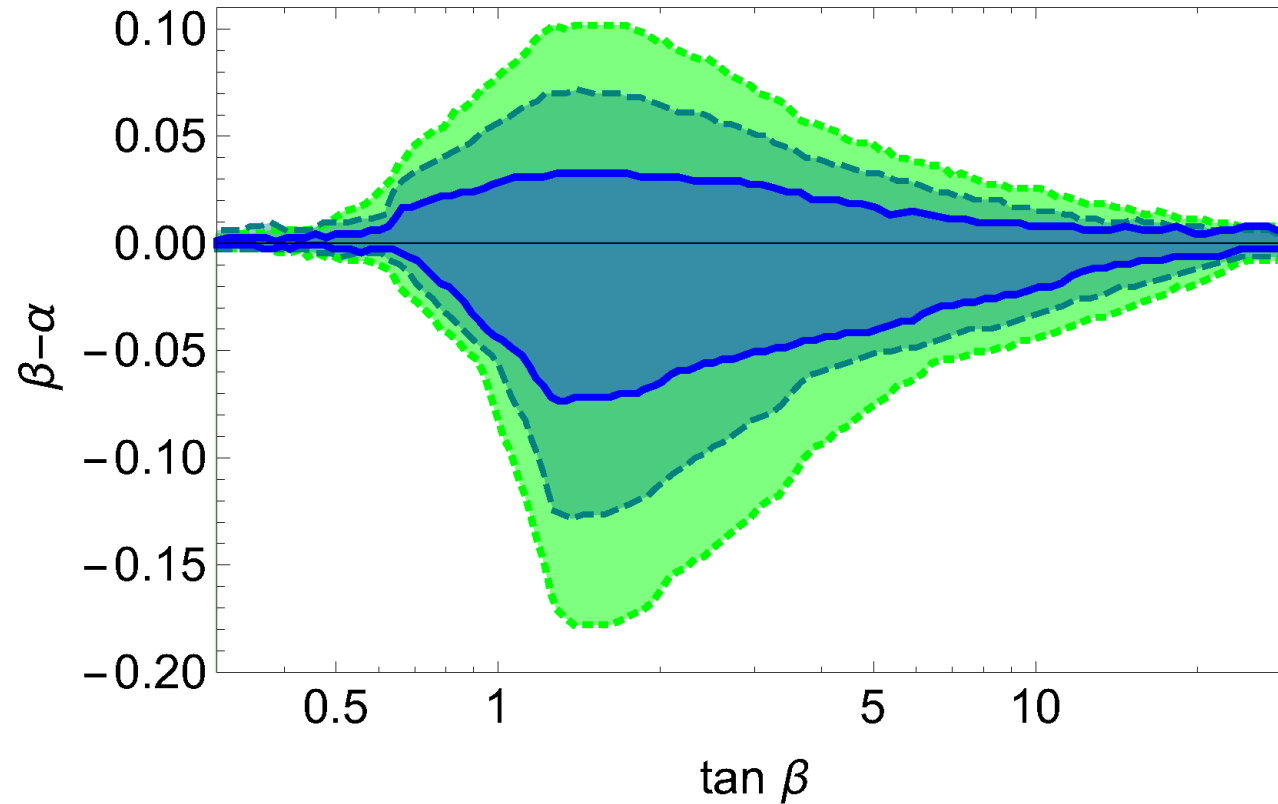

Pheno favoured limit $\beta \rightarrow \alpha$: $g_{HVV} = \cos(\beta - \alpha) \rightarrow g_{H_{SM}VV} = 1$.

• **SM Alignment** $\beta \rightarrow \alpha$:

(i) **Decoupling:** [Georgi, Nanopoulos '79; Gunion, Haber '03; Ginzburg, Krawczyk '05]

$$M_h^2 \simeq M_a^2 + \lambda_5 v^2 \simeq M_{h^\pm}^2 \gg v_{\text{SM}}^2$$

$$M_H^2 \simeq 2\lambda_{\text{SM}} v^2 - \frac{v^4 s_\beta^2 c_\beta^2}{M_a^2 + \lambda_5 v^2} \left[s_\beta^2 (2\lambda_2 - \lambda_{345}) - c_\beta^2 (2\lambda_1 - \lambda_{345}) + \dots \right]^2$$

(ii) **Fine-tuning:** [Krawczyk et al. '99; Carena, Low, Shah, Wagner '14; Dev, AP '14]

$$\lambda_7 t_\beta^4 - (2\lambda_2 - \lambda_{345}) t_\beta^3 + 3(\lambda_6 - \lambda_7) t_\beta^2 + (2\lambda_1 - \lambda_{345}) t_\beta - \lambda_6 = 0$$

(iii) **Natural SM alignment** (independent of M_{h^\pm} and t_β): [Dev, AP '14]

$$\lambda_1 = \lambda_2 = \frac{\lambda_{345}}{2} \quad (\text{with } \lambda_{345} \equiv \lambda_3 + \lambda_4 + \lambda_5), \quad \lambda_6 = \lambda_7 = 0$$

Symmetries:

- Sp(4): $\lambda_4 = \lambda_5 = 0 \rightarrow \lambda_{345} = \lambda_3$
- SU(2): $\lambda_5 = 0 \rightarrow \lambda_{345} = \lambda_{34} \equiv \lambda_3 + \lambda_4$
- SO(2) \times CP: $\lambda_{3,4,5} \neq 0$

• Maximally Symmetric Two Higgs Doublet Model

[P.S.B. Dev, AP '14]

$$G_{\Phi} = \text{SU}(2)_L \otimes \text{Sp}(4)/\mathbb{Z}_2 \simeq \text{SU}(2)_L \otimes \text{SO}(5).$$

$$V = -\mu^2 \left(|\Phi_1|^2 + |\Phi_2|^2 \right) + \lambda \left(|\Phi_1|^2 + |\Phi_2|^2 \right)^2 = -\frac{\mu^2}{2} \Phi^\dagger \Phi + \frac{\lambda}{4} (\Phi^\dagger \Phi)^2,$$

where

[R. A. Battye, G. D. Brawn, AP, JHEP1108 (2011) 020.]

$$\Phi = \begin{pmatrix} \phi_1 \\ \phi_2 \\ i\sigma^2 \phi_1^* \\ i\sigma^2 \phi_2^* \end{pmatrix}, \quad \text{with } U_L \in \text{SU}(2)_L : \Phi \mapsto \Phi' = U_L \Phi,$$

such that under **global field transformations**, [AP, Phys. Lett. B706 (2012) 465.]

$$\text{Sp}(4) : \Phi \mapsto \Phi' = U \Phi, \quad \text{with } U \in \text{U}(4) \text{ \& } UCU^\top = C \equiv i\sigma^2 \otimes \sigma^0$$

SU(2)_L gauge kinetic terms remain invariant.

Breaking Effects: $-m_{12}^2 \phi_1^\dagger \phi_2$, $\text{U}(1)_Y$ coupling g' , Yukawa couplings $\mathbf{Y}^{u,d}$.

References (*an incomplete list on SM Alignment in the 2HDM*)

- **On the SM Higgs basis (also Decoupling of FCNC Effects):**
H. Georgi and D. V. Nanopoulos, Phys. Lett. B82 (1979) 95.
- **Alignment via Decoupling:**
 - J. F. Gunion, H. E. Haber, Phys. Rev. D67 (2003) 075019.
 - I. F. Ginzburg, M. Krawczyk, Phys. Rev. D72 (2005) 115013.
- **Alignment via Fine-tuning:**
 - P. H. Chankowski, T. Farris, B. Grzadkowski, J. F. Gunion, J. Kalinowski, M. Krawczyk, Phys. Lett. B496 (2000) 195.
 - A. Delgado, G. Nardini, M. Quiros, JHEP1307 (2013) 054.
 - M. Carena, I. Low, N. R. Shah, C. E. M. Wagner, JHEP1404 (2014) 015.
- **Natural Alignment without Decoupling and without Fine-tuning:**
 - P.S.B. Dev, AP, JHEP1412 (2014) 024.
 - B. Grzadkowski, O. M. Ogreid, P. Osland, Phys. Rev. D94 (2016) 115002.

References (*an incomplete list on symmetries in the 2HDM*)

- **Spontaneous CP Violation:** T. D. Lee, Phys. Rev. D8 (1973) 1226.
- **Z_2 symmetry:** S. L. Glashow, S. Weinberg, Phys. Rev. D15 (1977) 1958.
- **Inert Z_2 symmetry:** N. G. Deshpande, E. Ma, Phys. Rev. D18 (1978) 2574.
- **PQ $U(1)$ symmetry:** R. D. Peccei, H. R. Quinn, Phys. Rev. Lett. 38 (1977) 1440.
- **Custodial $SU(2)_L$ -preserving symmetry:**
P. Sikivie, L. Susskind, M. B. Voloshin, V. I. Zakharov, Nucl. Phys. B173 (1980) 189.
- **Bilinear formalism:**
M. Maniatis, A. von Manteuffel, O. Nachtmann, F. Nagel, EPJC48 (2006) 805;
C. C. Nishi, Phys. Rev. D74 (2006) 036003.
- **$SU(2)_L \otimes U(1)_Y$ -preserving symmetries: 6**
I. P. Ivanov, Phys. Rev. D75 (2007) 035001;
P. M. Ferreira, H. E. Haber, J. P. Silva, Phys. Rev. D79 (2009) 116004.
- **Hypercustodial $SU(2)_L$ -preserving symmetries: 13**
R. A. Battye, G. D. Brawn, AP, JHEP1108 (2011) 020.
- **On completeness and uniqueness of classification:**
AP, Phys. Lett. B706 (2012) 465.

• Natural Alignment Beyond the 2HDM

[AP '16]

– n HDM **potential** with m inert scalar doublets:

$$V_{n\text{HDM}} = V_{\text{sym}} + V_{\text{inert}} + \Delta V_{\text{soft}} ,$$

– **3** continuous **alignment symmetries** in the **field space of the active EWSB sector** ($N_H = n - m$):

$$(i) \text{ Sp}(2N_H) \times \mathcal{D} \quad (ii) \text{ SU}(N_H) \times \mathcal{D} \quad (iii) \text{ SO}(N_H) \times \mathcal{CP} \times \mathcal{D},$$

where \mathcal{D} acts on the inert sector *only*.

– **Symmetry invariants**:

$$(i) \quad S = \Phi_1^\dagger \Phi_1 + \Phi_2^\dagger \Phi_2 + \dots = \frac{1}{2} \Phi^\dagger \Phi$$

$$(ii) \quad D^a = \Phi_1^\dagger \sigma^a \Phi_1 + \Phi_2^\dagger \sigma^a \Phi_2 + \dots$$

$$(iii) \quad T = \Phi_1 \Phi_1^T + \Phi_2 \Phi_2^T + \dots$$

– **Symmetric part of the scalar potential**:

$$V_{\text{sym}} = -\mu^2 S + \lambda_S S^2 + \lambda_D D^a D^a + \lambda_T \text{Tr}(T T^*) .$$

– Inert part of the scalar potential:

$$V_{\text{inert}} = \widehat{m}_{\widehat{a}\widehat{b}}^2 \widehat{\Phi}_{\widehat{a}}^\dagger \widehat{\Phi}_{\widehat{b}} + \lambda_{\widehat{a}\widehat{b}\widehat{c}\widehat{d}} (\widehat{\Phi}_{\widehat{a}}^\dagger \widehat{\Phi}_{\widehat{b}}) (\widehat{\Phi}_{\widehat{c}}^\dagger \widehat{\Phi}_{\widehat{d}}) + \lambda_{\widehat{a}\widehat{b}cd} (\widehat{\Phi}_{\widehat{a}}^\dagger \widehat{\Phi}_{\widehat{b}}) (\Phi_c^\dagger \Phi_d) \\ + \lambda_{a\widehat{b}\widehat{c}d} (\Phi_a^\dagger \widehat{\Phi}_{\widehat{b}}) (\widehat{\Phi}_{\widehat{c}}^\dagger \Phi_d) + \left[\lambda_{a\widehat{b}c\widehat{d}} (\Phi_a^\dagger \widehat{\Phi}_{\widehat{b}}) (\Phi_c^\dagger \widehat{\Phi}_{\widehat{d}}) + \text{H.c.} \right]$$

$$\mathbf{Z}_2^I: \quad \Phi_a \rightarrow \Phi_a \quad (a = 1, 2, \dots, N_H), \quad \widehat{\Phi}_{\widehat{b}} \rightarrow -\widehat{\Phi}_{\widehat{b}} \quad (\widehat{b} = \widehat{1}, \widehat{2}, \dots, \widehat{m})$$

– Soft-symmetry Breaking:

$$\Delta V_{\text{soft}} = m_{ab}^2 \Phi_a^\dagger \Phi_b$$

– Minimal Symmetry of Alignment in the Higgs basis:

$$\mathbf{Z}_2^{\text{EW}}: \quad \Phi'_1 \rightarrow \Phi'_1, \quad \Phi'_{a'} \rightarrow -\Phi'_{a'} \quad (a' = 2, 3, \dots, N_H)$$

where m_{ab}^2 becomes diagonal.

$$\implies \boxed{\text{Minimal Alignment Symmetry: } \mathbf{Z}_2^{\text{EW}} \times \mathbf{Z}_2^I} \quad [\text{AP '16}]$$

- **Quartic coupling unification in the MS-2HDM**

[Dev, AP '14; N. Darvishi, AP '19]

Symmetry-breaking of $\text{Sp}(4)/\mathbb{Z}_2 \sim \text{SO}(5)$:

- Soft breaking (e.g. through m_{12}^2):

$$M_H^2 = 2\lambda_2 v^2, \quad M_h^2 = M_a^2 = M_{h^\pm}^2 = \frac{\text{Re}(m_{12}^2)}{s_\beta c_\beta}$$

Heavy Higgs spectrum is **degenerate** at tree level.

- **Explicit breaking** through **RG running** (two loops):

$$\begin{aligned} \text{Sp}(4)/\mathbb{Z}_2 \otimes \text{SU}(2)_L &\xrightarrow{g' \neq 0} \text{SU}(2)_{\text{HF}} \otimes \text{U}(1)_Y \otimes \text{SU}(2)_L \\ &\xrightarrow{\mathbf{Y}^{u,d}} \text{U}(1)_{\text{PQ}} \otimes \text{U}(1)_Y \otimes \text{SU}(2)_L \\ &\xrightarrow[\langle \Phi_{1,2} \rangle]{m_{12}^2} \text{U}(1)_{\text{em}} \end{aligned}$$

• **Quartic Coupling Unification (two loops)**

[N. Darvishi, AP '19]

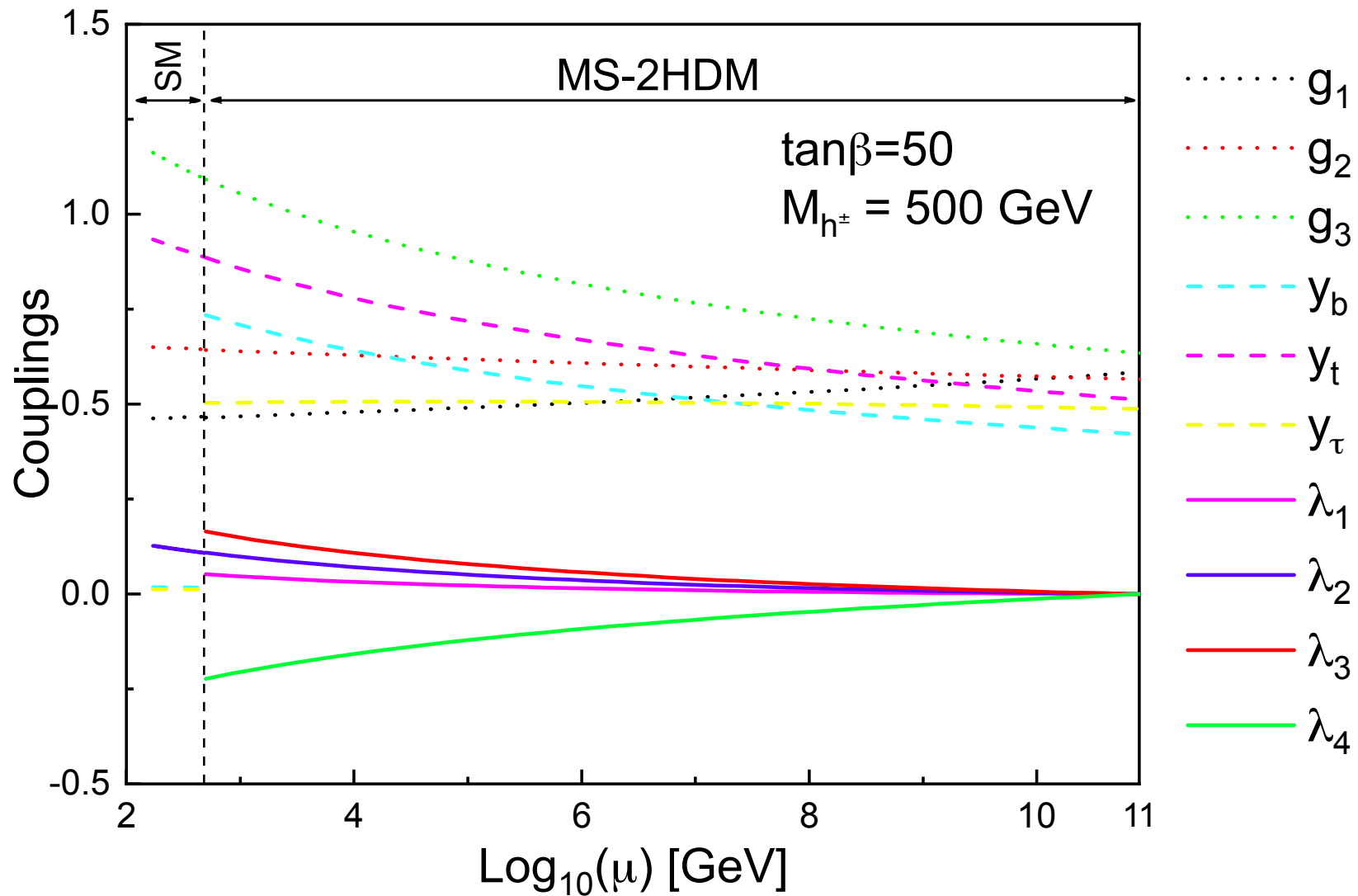

First conformal unification point: $\mu_X^{(1)} \sim 10^{11}$ GeV (of order PQ scale)

Second conformal unification point: $\mu_X^{(2)} \sim 10^{18}$ GeV (of order m_{Pl})

[N. Darvishi, AP '19]

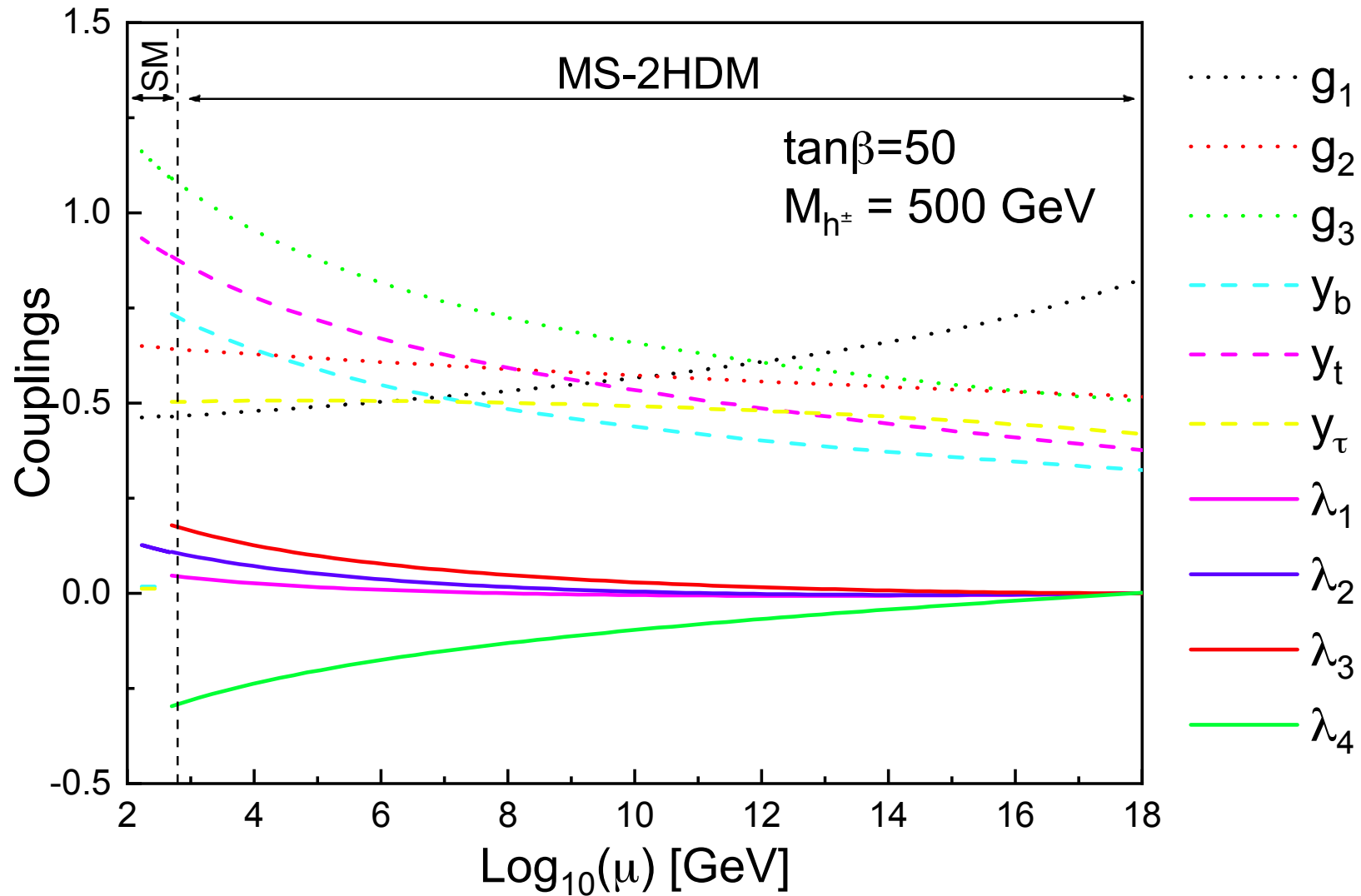

A closer look at the RG evolution of λ_2

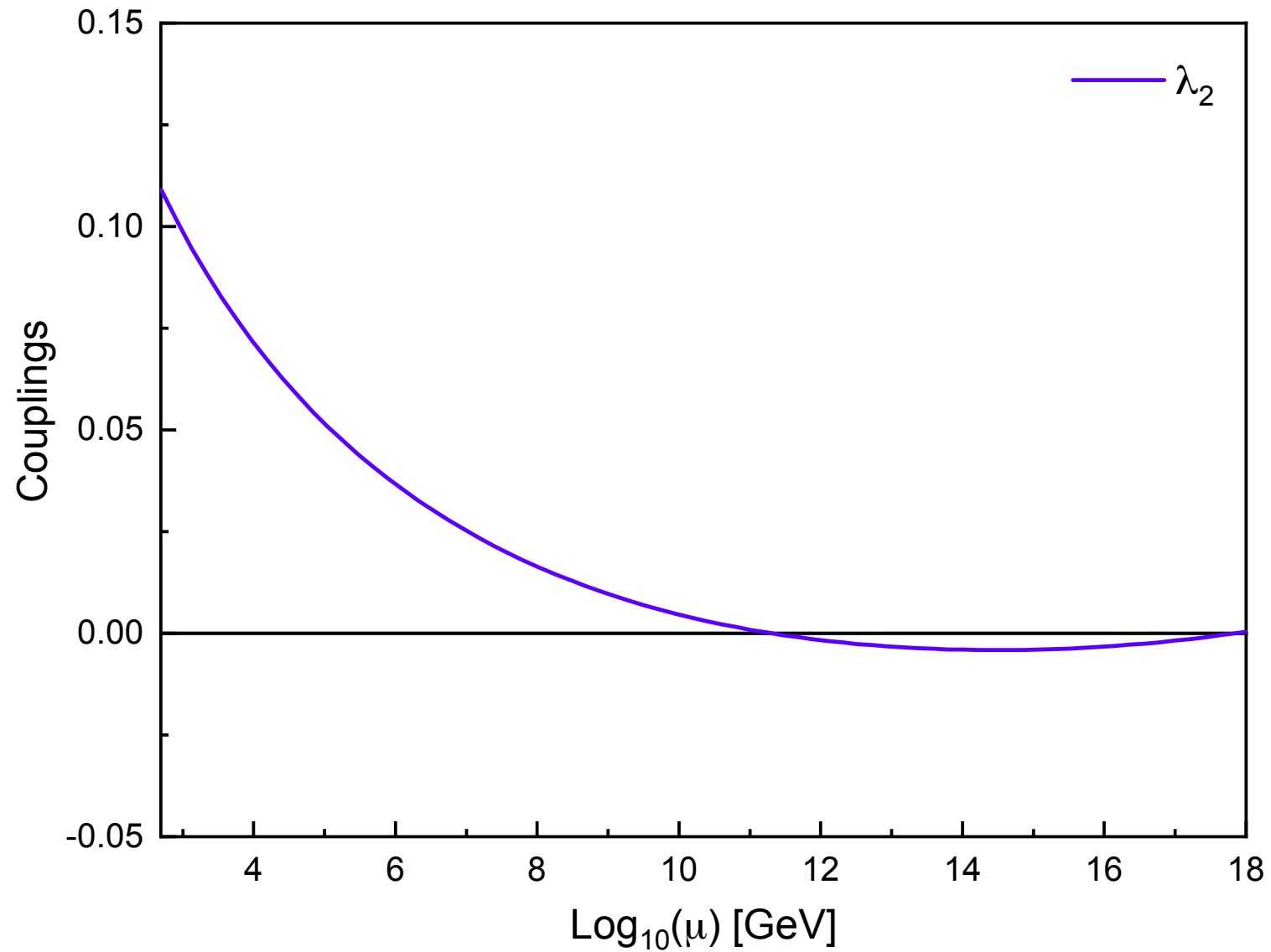

Low- and high-scale quartic coupling unification: $\tan \beta$ vs $\mu_X^{(1,2)}$

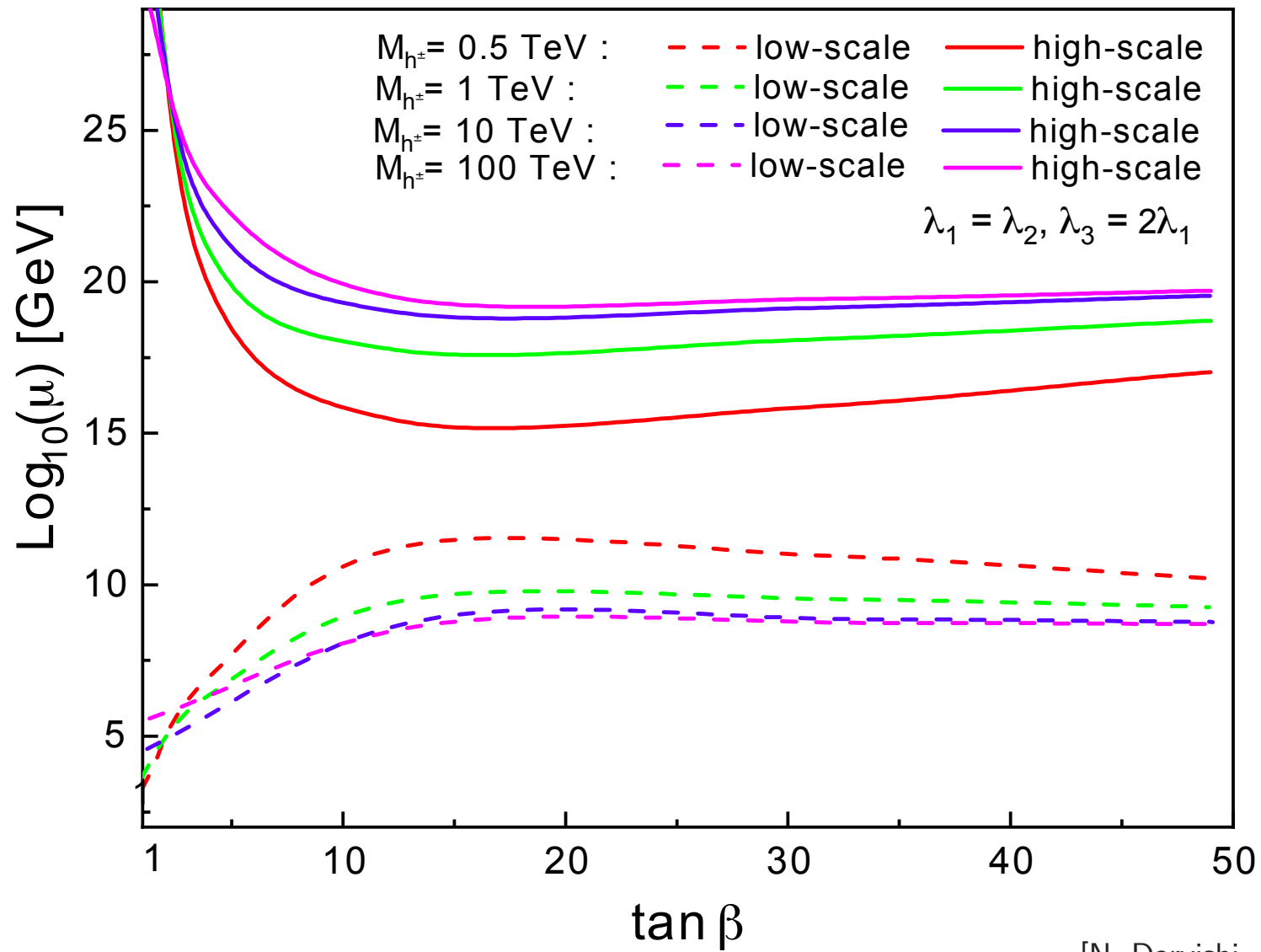

[N. Darvishi, AP '19]

- **Misalignment in the MS-2HDM**

CP-even mass matrix in Higgs basis:

$$\mathcal{M}_S^2 = \begin{pmatrix} \hat{A} & \hat{C} \\ \hat{C} & \hat{B} \end{pmatrix} \xrightarrow[\text{approx.}]{\text{seesaw}} M_H^2 \simeq \hat{A} - \frac{\hat{C}^2}{\hat{B}} \quad \& \quad M_h^2 \simeq \hat{B} \gg \hat{A}, \hat{C}$$

Light-to-heavy scalar mixing:

$$\theta_S \equiv \frac{\hat{C}}{\hat{B}} = \frac{v^2 s_\beta c_\beta [s_\beta^2 (2\lambda_2 - \lambda_{34}) - c_\beta^2 (2\lambda_1 - \lambda_{34})]}{M_a^2 + 2v^2 s_\beta^2 c_\beta^2 (\lambda_1 + \lambda_2 - \lambda_{34})} \ll 1$$

Higgs couplings to $V = W, Z$:

$$g_{HVV} \simeq 1 - \frac{1}{2} \theta_S^2, \quad g_{hVV} \simeq -\theta_S$$

Higgs couplings to quarks:

$$\begin{aligned} g_{Huu} &\simeq 1 + t_\beta^{-1} \theta_S, & g_{Hdd} &\simeq 1 - t_\beta \theta_S, \\ g_{huu} &\simeq -\theta_S + t_\beta^{-1}, & g_{hdd} &\simeq -\theta_S - t_\beta. \end{aligned}$$

Predictions for Higgs-boson couplings to $V = W, Z$ and b -quarks

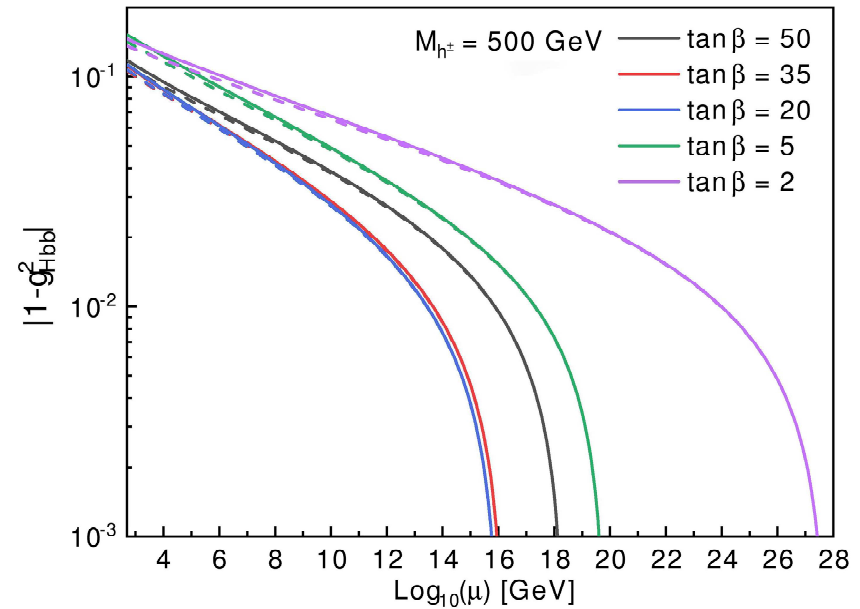
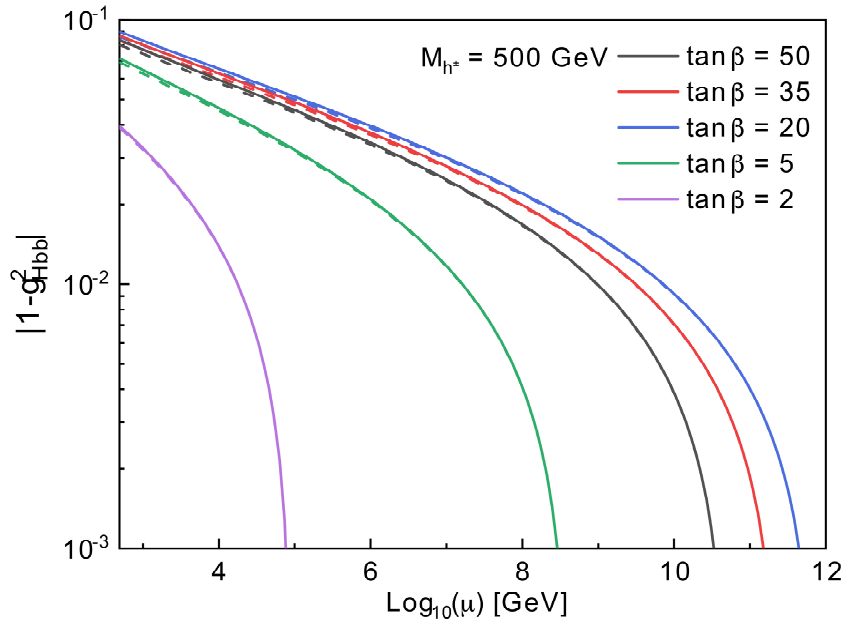
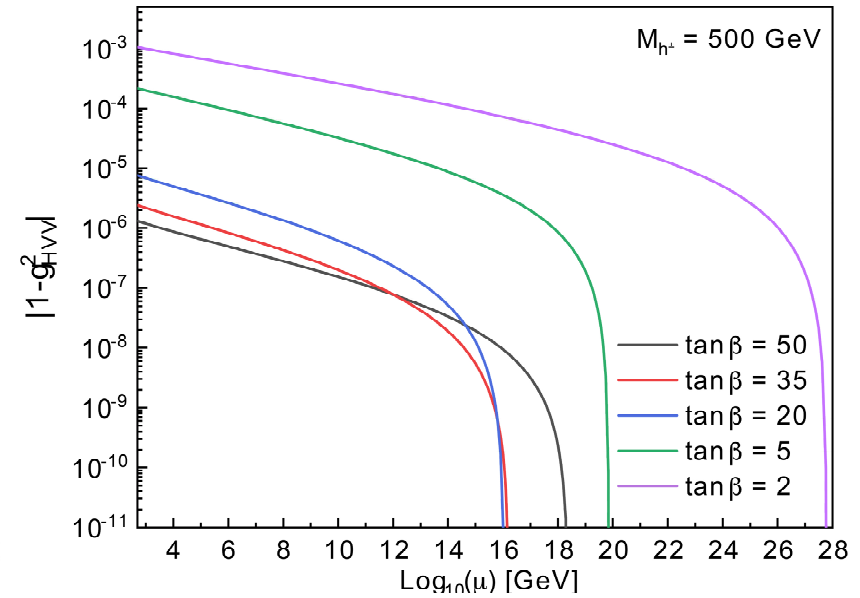
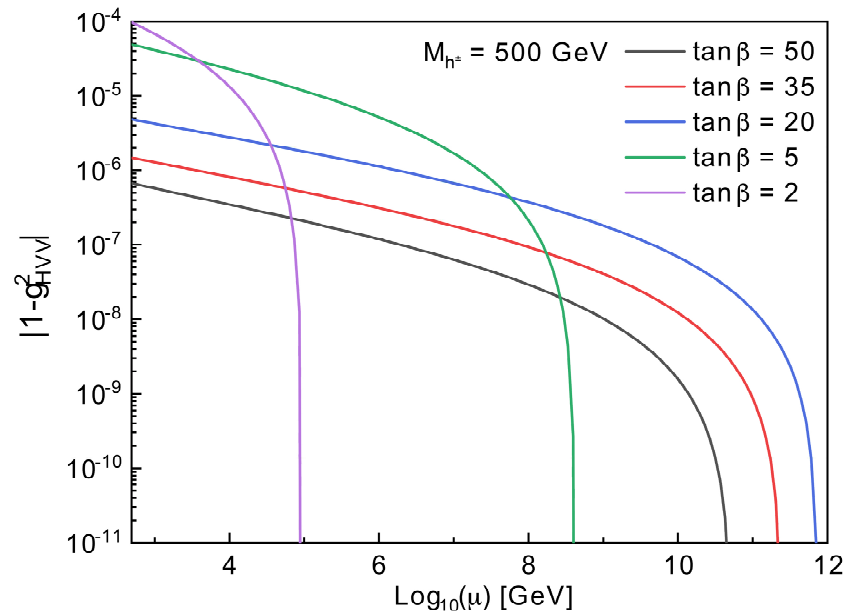

Misalignment predictions in the MS-2HDM with low- and **high-scale** quartic coupling unification, assuming $M_{h^\pm} = 500$ GeV.

[N. Darvishi, AP '19]

Couplings	ATLAS	CMS	$\tan \beta = 2$	$\tan \beta = 20$	$\tan \beta = 50$
$ g_{HZZ}^{\text{low-scale}} $	[0.86, 1.00]	[0.90, 1.00]	0.9999	0.9999	0.9999
$ g_{HZZ}^{\text{high-scale}} $			0.9981	0.9999	0.9999
$ g_{Htt}^{\text{low-scale}} $	$1.31^{+0.35}_{-0.33}$	$1.45^{+0.42}_{-0.32}$	1.0049	1.0001	1.0000
$ g_{Htt}^{\text{high-scale}} $			1.0987	1.0003	1.0001
$ g_{Hbb}^{\text{low-scale}} $	$0.49^{+0.26}_{-0.19}$	$0.57^{+0.16}_{-0.16}$	0.9803	0.9560	0.9590
$ g_{Hbb}^{\text{high-scale}} $			0.8810	0.9449	0.9427

→ **Misalignment predictions** consistent with experiment

• Phenomenological implications at the LHC

Discovery channels for aligned Higgs doublets:

- $gg \rightarrow t\bar{b}h^- \rightarrow t\bar{t}b\bar{b}$

[Dev, AP '14]

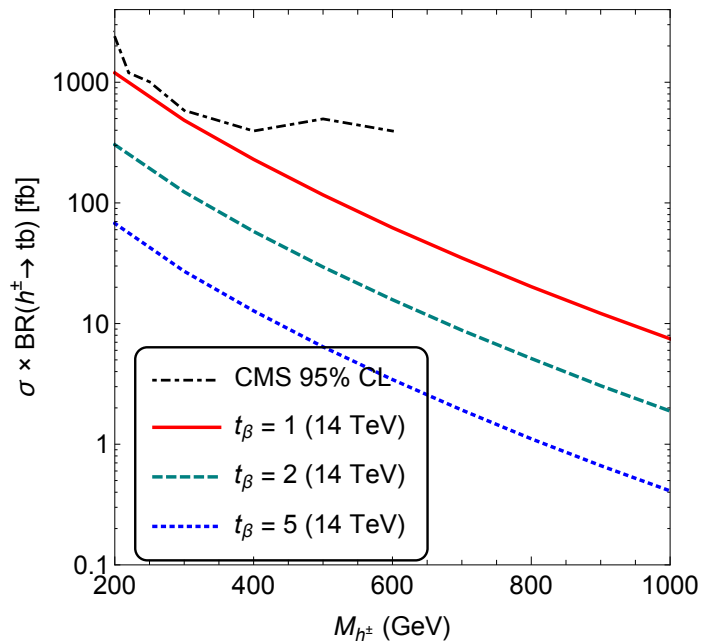
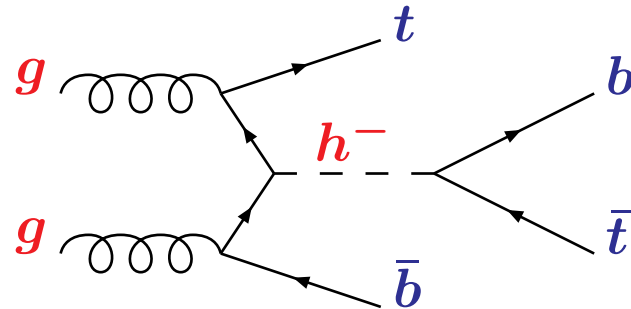

$$\begin{aligned}
 p_T^l &> 20 \text{ GeV}, \\
 |\eta^l| &< 2.5, \\
 \Delta R^{\ell\ell} &> 0.4, \\
 M_{\ell\ell} &> 12 \text{ GeV}, \\
 |M_{\ell\ell} - M_Z| &> 10 \text{ GeV}, \\
 p_T^j &> 30 \text{ GeV}, \\
 |\eta^j| &< 2.4, \\
 \cancel{E}_T &> 40 \text{ GeV}.
 \end{aligned}$$

- $gg \rightarrow t\bar{t}(h, a) \rightarrow t\bar{t}t\bar{t}$

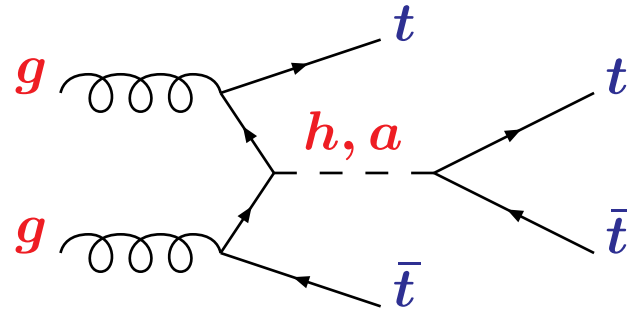

[Dev, AP '14]

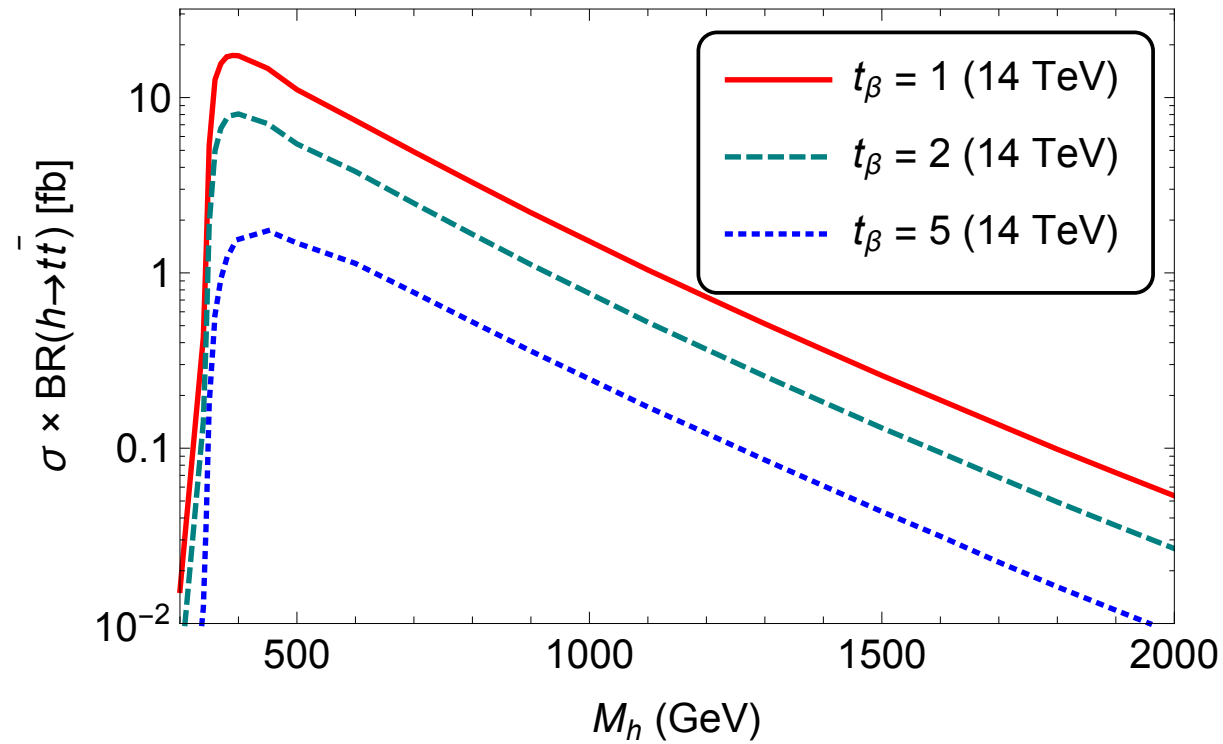

Realistic simulation analysis with a reconstruction BDT

[Emily Hanson, W. Klemm, R. Naranjo, Yvonne Peters, AP, PRD100 (2019) 035026]

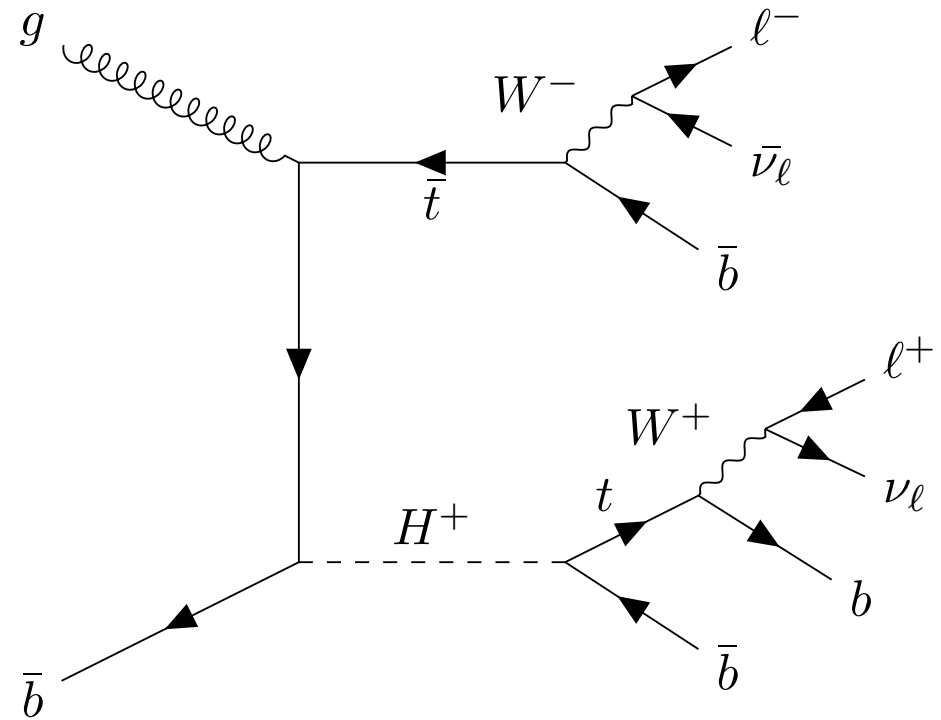
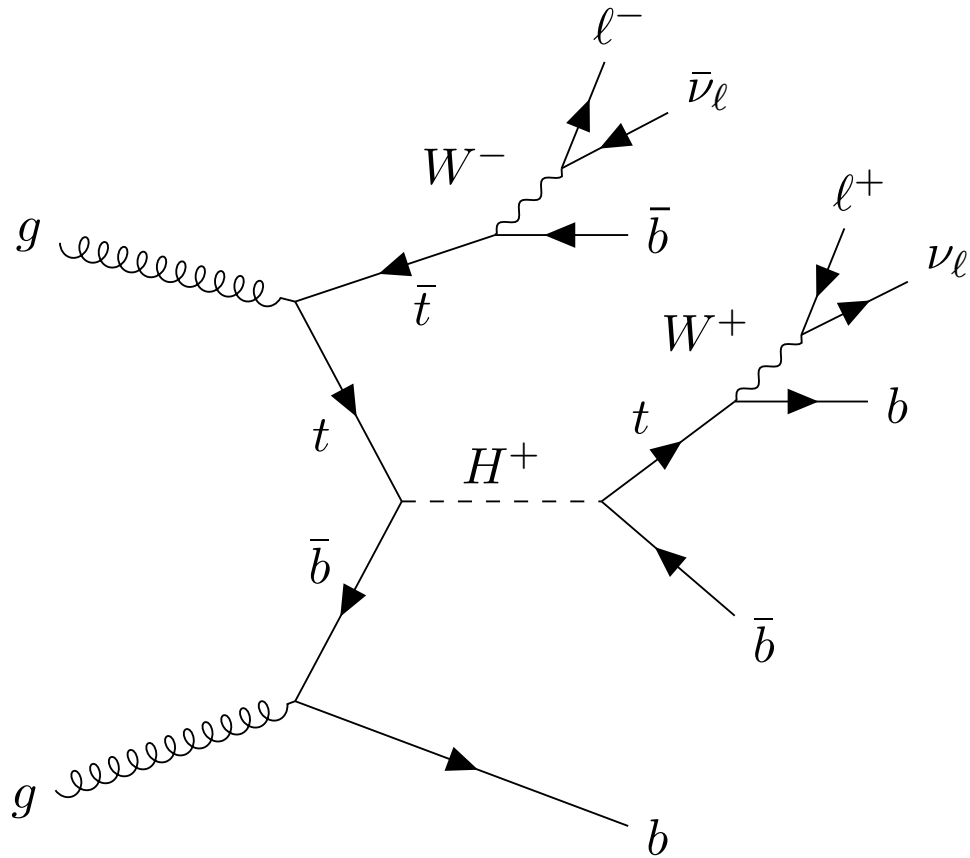

Reconstruction BDT trained on 57 observables:

- $\Delta R(b_i, l^a), \Delta\eta(b_i, l^a), \Delta\phi(b_i, l^a), p_T^{b_i+l^a}, m(b_i, l^a)$,
where $i = tH, t$ and $a = +, -$
- $|m(l^+, b_{tH}) - m(l^-, b_t)|$ and $|m(l^-, b_{tH}) - m(l^+, b_t)|$
- $p_T^{b_j}$, where $j = tH, H, t$
- $\Delta R(b_{tH}, b_k), \Delta\eta(b_{tH}, b_k), \Delta\phi(b_{tH}, b_k), p_T^{b_{tH}+b_k}, m(b_{tH}, b_k)$, where $k = H, t$
- $\Delta R(t_{H^a}, b_H), \Delta\eta(t_{H^a}, b_H), \Delta\phi(t_{H^a}, b_H), p_T^{t_{H^a}, b_H}, m(t_{H^a}, b_H)$,
where $a = +, -$
- $\Delta R(t_{H^a}, t_c), \Delta\eta(t_{H^a}, t_c), \Delta\phi(t_{H^a}, t_c)$, where $(H^a, t_c) = (H^+, \bar{t})$ or (H^-, t)
- $m(H^a) - m(b_H)$, where $a = +, -$
- $m(H^+) - m(\bar{t})$ and $m(H^-) - m(t)$
- $p_T^{H^\pm+t_{\text{other}}}$
- $m(H^\pm, t_{\text{other}})$

Results

[Emily Hanson, W. Klemm, R. Naranjo, Yvonne Peters, AP, PRD100 (2019) 035026]

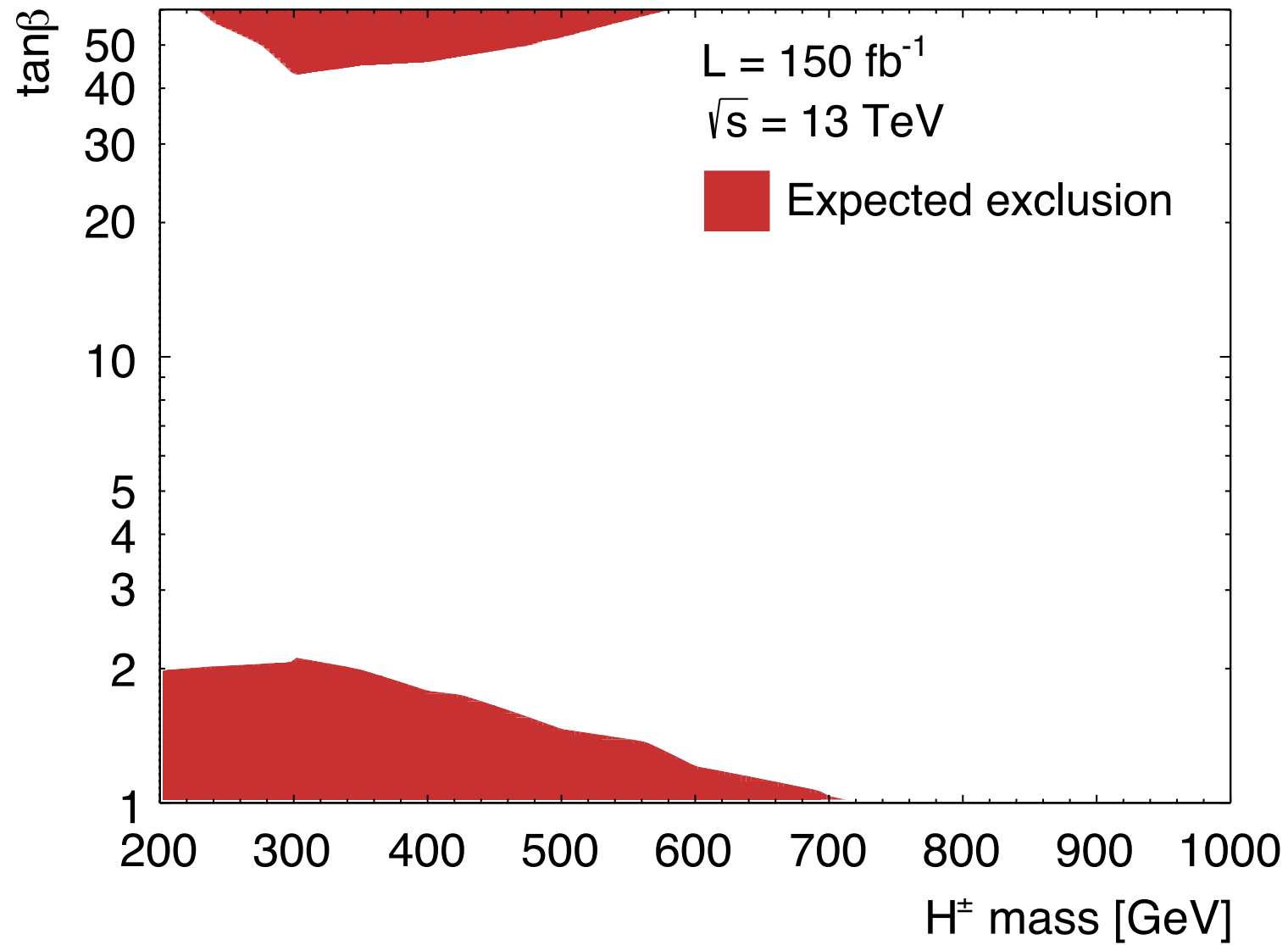

• Conclusions

- Symmetries for **natural alignment** *without* decoupling in multi-HDMs:

$$(i) \text{ Sp}(2N_H) \quad (ii) \text{ SU}(N_H) \quad (iii) \text{ SO}(N_H) \times \mathcal{CP}$$

$N_H > 1$: number of **EWSB Higgs doublets**

- **Soft breaking** \longrightarrow **minimal alignment symmetry**: $\mathbb{Z}_2^{\text{EW}} \times \mathbb{Z}_2^{\text{I}}$
 \longrightarrow **Naturally aligned heavy Higgs sector** is \mathbb{Z}_2^{EW} **odd**.

- **Quartic coupling unification** for maximally symmetric n HDMs:

$$G_{\Phi} = \text{SU}(2)_L \otimes \text{Sp}(2n)/\mathbb{Z}_2 \quad (\text{here } n = 2).$$

INPUT: $M_{h_{\pm}}$ & $\tan \beta \rightarrow \mu_X^{(1)} \sim 10^{11} \text{ GeV}$ & $\mu_X^{(2)} \sim 10^{19} \text{ GeV}$.

- **Two-loop RG** effects give rise to **definite misalignment predictions** for *all H-couplings* to **SM particles** in terms of $M_{h_{\pm}}$ & $\tan \beta$.

- Probing **new aligned Higgs doublets** **via** the **production channels**:

(a) $gg \rightarrow t\bar{t}h^- \rightarrow t\bar{t}b\bar{b}$

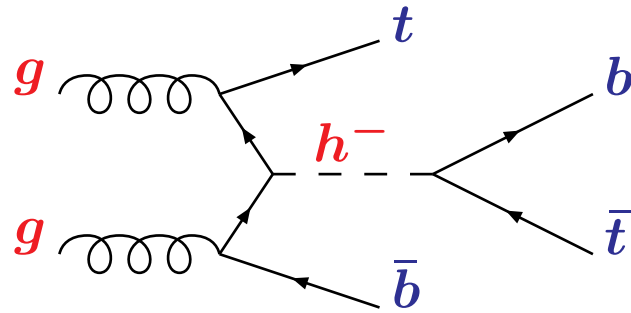

(b) $gg \rightarrow t\bar{t}(h, a) \rightarrow t\bar{t}t\bar{t}$

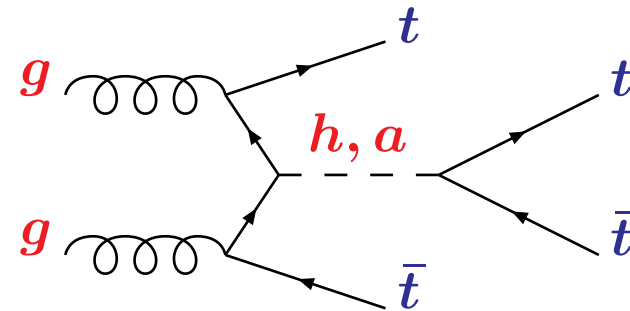

More experimental analyses needed

Back-Up Slides

• Symmetries of the 2HDM Potential

[R. A. Battye, G. D. Brawn, AP, JHEP1108 (2011) 020.]

Introduce the $SU(2)_L$ -covariant 8D complex field multiplet

$$\Phi = \begin{pmatrix} \phi_1 \\ \phi_2 \\ i\sigma^2\phi_1^* \\ i\sigma^2\phi_2^* \end{pmatrix}, \quad \text{with } U_L \in SU(2)_L : \Phi \mapsto \Phi' = U_L \Phi.$$

Φ satisfies the **Majorana constraint**

$$\Phi = C \Phi^*,$$

where C is the **charge conjugation 8D matrix**

$$C = \sigma^2 \otimes \sigma^0 \otimes \sigma^2 = \begin{pmatrix} \mathbf{0}_4 & \mathbf{1}_4 \\ -\mathbf{1}_4 & \mathbf{0}_4 \end{pmatrix} \otimes (-i\sigma_2).$$

- **The SO(1,5) Bilinear Formalism**

Introduce the *null 6-Vector*

$$R^A = \Phi^\dagger \Sigma^A \Phi = \begin{pmatrix} \phi_1^\dagger \phi_1 + \phi_2^\dagger \phi_2 \\ \phi_1^\dagger \phi_2 + \phi_2^\dagger \phi_1 \\ -i \left[\phi_1^\dagger \phi_2 - \phi_2^\dagger \phi_1 \right] \\ \phi_1^\dagger \phi_1 - \phi_2^\dagger \phi_2 \\ \phi_1^\top i \sigma^2 \phi_2 - \phi_2^\dagger i \sigma^2 \phi_1^* \\ -i \left[\phi_1^\top i \sigma^2 \phi_2 + \phi_2^\dagger i \sigma^2 \phi_1^* \right] \end{pmatrix},$$

with $A = \mu, 4, 5$ and

$$\Sigma^\mu = \frac{1}{2} \begin{pmatrix} \sigma^\mu & \mathbf{0}_2 \\ \mathbf{0}_2 & (\sigma^\mu)^\top \end{pmatrix} \otimes \sigma^0,$$

$$\Sigma^4 = \frac{1}{2} \begin{pmatrix} \mathbf{0}_2 & i\sigma^2 \\ -i\sigma^2 & \mathbf{0}_2 \end{pmatrix} \otimes \sigma^0, \quad \Sigma^5 = \frac{1}{2} \begin{pmatrix} \mathbf{0}_2 & -\sigma^2 \\ -\sigma^2 & \mathbf{0}_2 \end{pmatrix} \otimes \sigma^0.$$

- The **2HDM Potential** in the **SO(1,5) Formalism**

$$V = -\frac{1}{2} M_A R^A + \frac{1}{4} L_{AB} R^A R^B ,$$

with

$$M_A = (\mu_1^2 + \mu_2^2, \quad 2\text{Re}(m_{12}^2), \quad -2\text{Im}(m_{12}^2), \quad \mu_1^2 - \mu_2^2, \quad 0, \quad 0) ,$$

$$L_{AB} = \begin{pmatrix} \lambda_1 + \lambda_2 + \lambda_3 & \text{Re}(\lambda_6 + \lambda_7) & -\text{Im}(\lambda_6 + \lambda_7) & \lambda_1 - \lambda_2 & 0 & 0 \\ \text{Re}(\lambda_6 + \lambda_7) & \lambda_4 + \text{Re}(\lambda_5) & -\text{Im}(\lambda_5) & \text{Re}(\lambda_6 - \lambda_7) & 0 & 0 \\ -\text{Im}(\lambda_6 + \lambda_7) & -\text{Im}(\lambda_5) & \lambda_4 - \text{Re}(\lambda_5) & -\text{Im}(\lambda_6 - \lambda_7) & 0 & 0 \\ \lambda_1 - \lambda_2 & \text{Re}(\lambda_6 - \lambda_7) & -\text{Im}(\lambda_6 - \lambda_7) & \lambda_1 + \lambda_2 - \lambda_3 & 0 & 0 \\ 0 & 0 & 0 & 0 & 0 & 0 \\ 0 & 0 & 0 & 0 & 0 & 0 \end{pmatrix} .$$

- **The 2HDM Potential in the SO(1,5) Formalism**

$$V = -\frac{1}{2} M_A R^A + \frac{1}{4} L_{AB} R^A R^B ,$$

with

$$M_A = (\mu_1^2 + \mu_2^2, \quad 2\text{Re}(m_{12}^2), \quad -2\text{Im}(m_{12}^2), \quad \mu_1^2 - \mu_2^2, \quad 0, \quad 0) ,$$

$$L_{AB} = \begin{pmatrix} \lambda_1 + \lambda_2 + \lambda_3 & \text{Re}(\lambda_6 + \lambda_7) & -\text{Im}(\lambda_6 + \lambda_7) & \lambda_1 - \lambda_2 & 0 & 0 \\ \text{Re}(\lambda_6 + \lambda_7) & \lambda_4 + \text{Re}(\lambda_5) & -\text{Im}(\lambda_5) & \text{Re}(\lambda_6 - \lambda_7) & 0 & 0 \\ -\text{Im}(\lambda_6 + \lambda_7) & -\text{Im}(\lambda_5) & \lambda_4 - \text{Re}(\lambda_5) & -\text{Im}(\lambda_6 - \lambda_7) & 0 & 0 \\ \lambda_1 - \lambda_2 & \text{Re}(\lambda_6 - \lambda_7) & -\text{Im}(\lambda_6 - \lambda_7) & \lambda_1 + \lambda_2 - \lambda_3 & 0 & 0 \\ 0 & 0 & 0 & 0 & 0 & 0 \\ 0 & 0 & 0 & 0 & 0 & 0 \end{pmatrix} .$$

- **Unitary Field Transformations:**

[AP, Phys. Lett. B706 (2012) 465.]

$$\text{Sp}(4) : \quad \Phi \mapsto \Phi' = U \Phi , \quad \text{with } U \in \text{U}(4) \quad \underline{\text{and}} \quad UCU^T = C$$

$$\text{SO}(5) : \quad R^I \mapsto R'^I = O^I_J R^J , \quad \text{with } O \in \text{SO}(5) \subset \text{SO}(1,5)$$

$$\implies \quad \text{SO}(5) \sim \text{Sp}(4)/\mathbf{Z}_2$$

- **Symmetries of the U(1) γ -Invariant 2HDM Potential**

SO(5)-diagonally **reduced** basis: $\text{Im } \lambda_5 = 0$ and $\lambda_6 = \lambda_7$.

The **2HDM potential** exhibits a **total** of **13** accidental symmetries:

Symmetry	μ_1^2	μ_2^2	m_{12}^2	λ_1	λ_2	λ_3	λ_4	Re λ_5	$\lambda_6 = \lambda_7$
$(\mathbb{Z}_2)^2 \times \text{SO}(2)$	–	–	0	–	–	–	–	–	0
$\text{O}(2) \times \text{O}(2)$	–	–	0	–	–	–	–	0	0
✓ $\mathbf{O}(3) \times \mathbf{O}(2)$	–	μ_1^2	0	–	λ_1	–	$2\lambda_1 - \lambda_3$	0	0
$\mathbb{Z}_2 \times \text{O}(2)$	–	–	Real	–	–	–	–	–	Real
$(\mathbb{Z}_2)^3 \times \text{O}(2)$	–	μ_1^2	0	–	λ_1	–	–	–	0
✓ $\mathbf{Z}_2 \times [\mathbf{O}(2)]^2$	–	μ_1^2	0	–	λ_1	–	–	$2\lambda_1 - \lambda_{34}$	0
✓ $\mathbf{SO}(5)$	–	μ_1^2	0	–	λ_1	$2\lambda_1$	0	0	0
$\mathbb{Z}_2 \times \text{O}(4)$	–	μ_1^2	0	–	λ_1	–	0	0	0
SO(4)	–	–	0	–	–	–	0	0	0
$\text{O}(2) \times \text{O}(3)$	–	μ_1^2	0	–	λ_1	$2\lambda_1$	–	0	0
$(\mathbb{Z}_2)^2 \times \text{SO}(3)$	–	μ_1^2	0	–	λ_1	–	–	$\pm\lambda_4$	0
$\mathbb{Z}_2 \times \text{O}(3)$	–	μ_1^2	Real	–	λ_1	–	–	λ_4	Real
SO(3)	–	–	Real	–	–	–	–	λ_4	Real

✓: **Natural SM Alignment** \mapsto

[Dev, AP, JHEP1412 (2014) 024.]

• Symmetry Breaking Scenarios and pseudo-Goldstone Bosons

[AP, Phys. Lett. B706 (2012) 465.]

No	Symmetry	Generators $T^a \leftrightarrow K^a$	Discrete Group Elements	Maximally Broken SO(5) Generators	Number of Pseudo- Goldstone Bosons
1	$Z_2 \times O(2)$	T^0	D_{CP1}	–	0
2	$(Z_2)^2 \times SO(2)$	T^0	D_{Z_2}	–	0
3	$(Z_2)^3 \times O(2)$	T^0	D_{CP2}	–	0
4	$O(2) \times O(2)$	T^3, T^0	–	T^3	1 (a)
✓ 5	$Z_2 \times [O(2)]^2$	T^2, T^0	D_{CP1}	T^2	1 (h)
✓ 6	$O(3) \times O(2)$	$T^{1,2,3}, T^0$	–	$T^{1,2}$	2 (h, a)
7	$SO(3)$	$T^{0,4,6}$	–	$T^{4,6}$	2 (h^\pm)
8	$Z_2 \times O(3)$	$T^{0,4,6}$	$D_{Z_2} \cdot D_{CP2}$	$T^{4,6}$	2 (h^\pm)
9	$(Z_2)^2 \times SO(3)$	$T^{0,5,7}$	$D_{CP1} \cdot D_{CP2}$	$T^{5,7}$	2 (h^\pm)
10	$O(2) \times O(3)$	$T^3, T^{0,8,9}$	–	T^3	1 (a)
11	$SO(4)$	$T^{0,3,4,5,6,7}$	–	$T^{3,5,7}$	3 (a, h^\pm)
12	$Z_2 \times O(4)$	$T^{0,3,4,5,6,7}$	$D_{Z_2} \cdot D_{CP2}$	$T^{3,5,7}$	3 (a, h^\pm)
✓ 13	$SO(5)$	$T^{0,1,2,\dots,9}$	–	$T^{1,2,8,9}$	4 (h, a, h^\pm)

✓: Natural SM Alignment \mapsto

[Dev, AP, JHEP1412 (2014) 024.]